

BOX DRAGON

- Start with colored stretched bird base.
- A 6 inch square makes a 3 1/2 inch long model.

Jim Adams

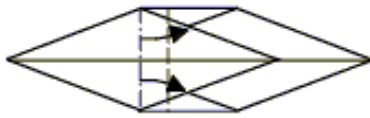

1. Start with a colored stretched bird base.

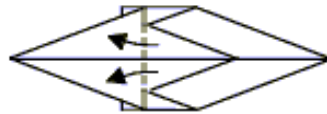

2.

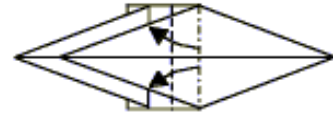

3.

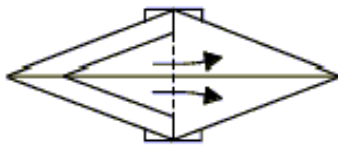

4.

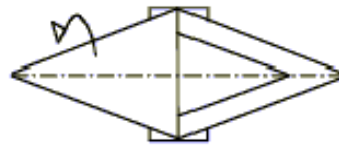

5.

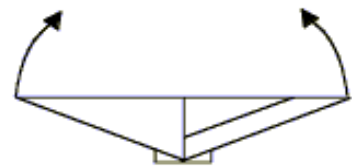

6. Rotate ends up as far as they will go.

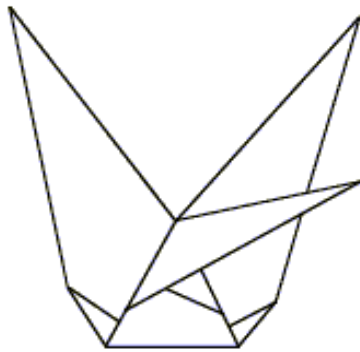

7.

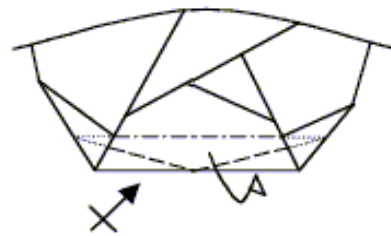

8.

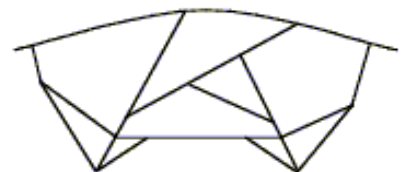

9.

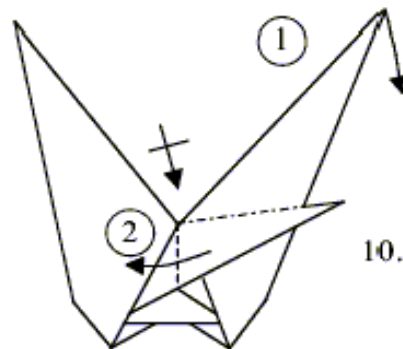

10. Inside reverse fold tail, then swing wings to the left.

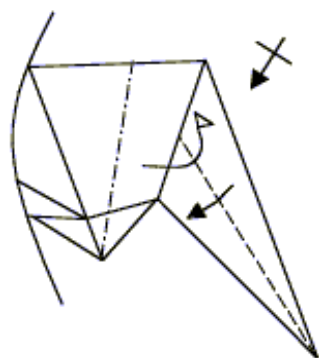

11. Inside reverse fold.
Repeat behind.

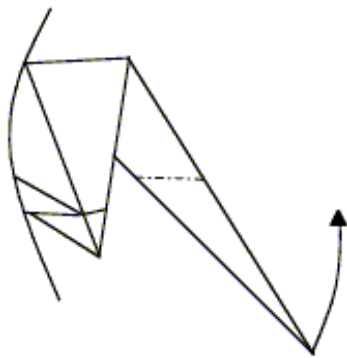

12. Inside reverse fold.

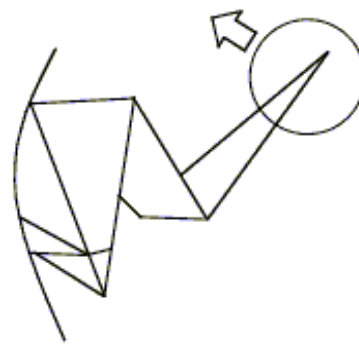

13. Open end of tail out and
press flat. See step 14.

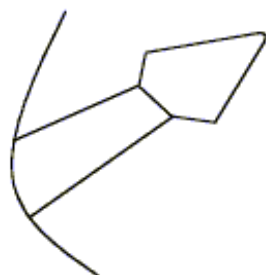

14.

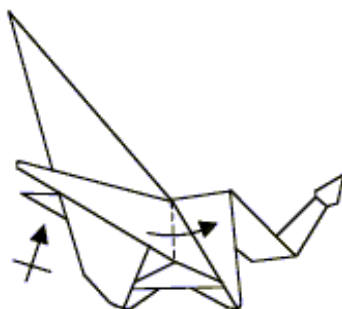

15. Swing wings back to the
right.



16. Outside reverse fold.

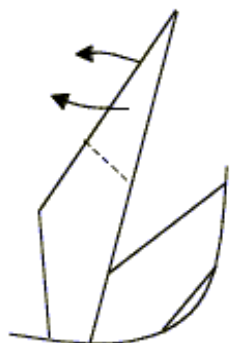

17. Outside reverse fold.

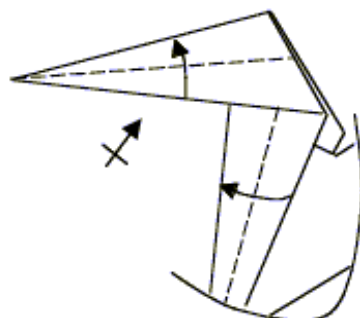

18. Swivel fold. Repeat behind.

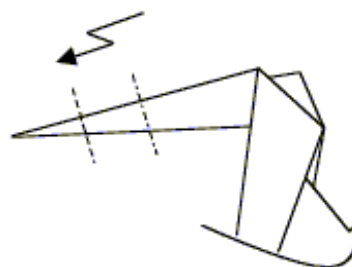

19. Crimp fold.

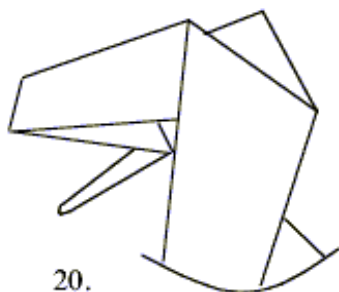

20.

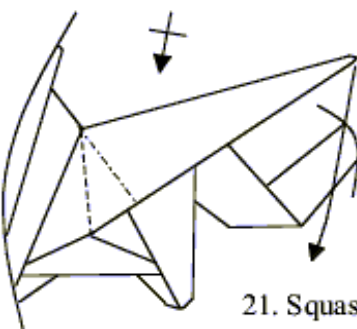

21. Squash fold. Repeat behind.

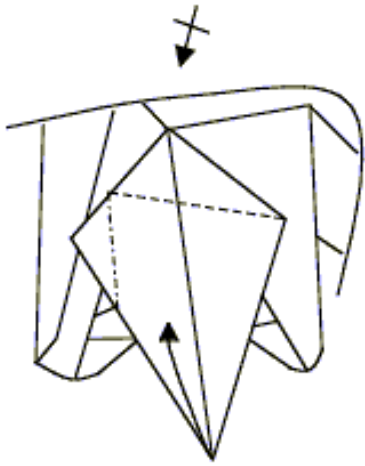

22. Open wing. Repeat behind.

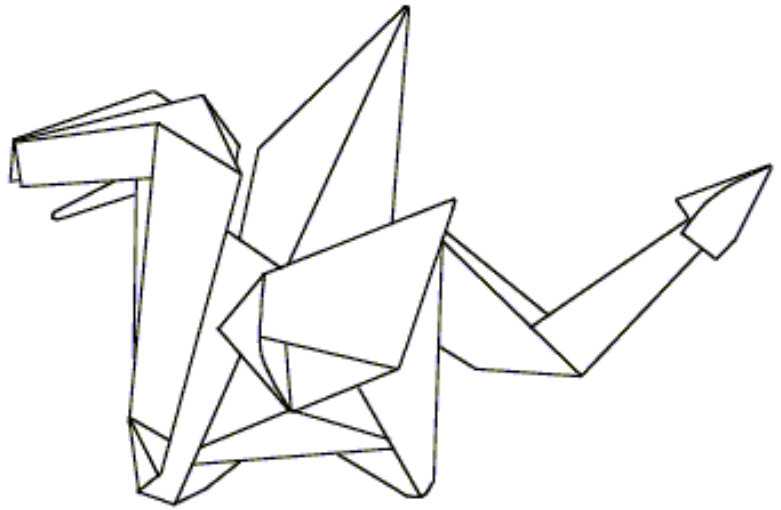

23.